

# SMART MOUNT

N°	Descrizione	Caratteristiche	Codice	Quantità
1	Smart Mount	-	S901A	1

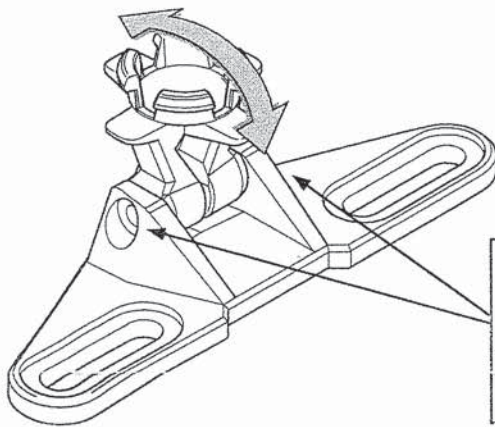

. ALLENTARE LE VITI PER POTER INCLINARE LA SMART MOUNT.  
 . LOOSEN THE BOLTS TO ADJUST THE ROTATION OF THE SMART MOUNT.  
 . DESSERREZ LES BOULONS POUR POUVOIR INCLINER LE MOUNT.  
 . LOCKERN SIE DIE SCHRAUBEN, UM DIE SMART MOUNT ZU NEIGEN ODER.  
 . AFLOJAR LOS TORNILLOS PARA PODER INCLINAR EL SMART-MOUNT  
 . SOLTE OS PARAFUSOS PARA AJUSTAR A ROTAÇÃO DO SMART MOUNT.

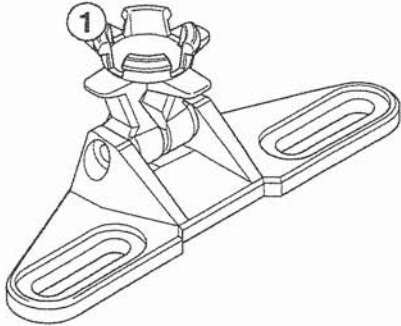
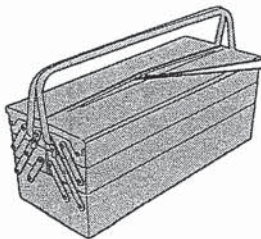
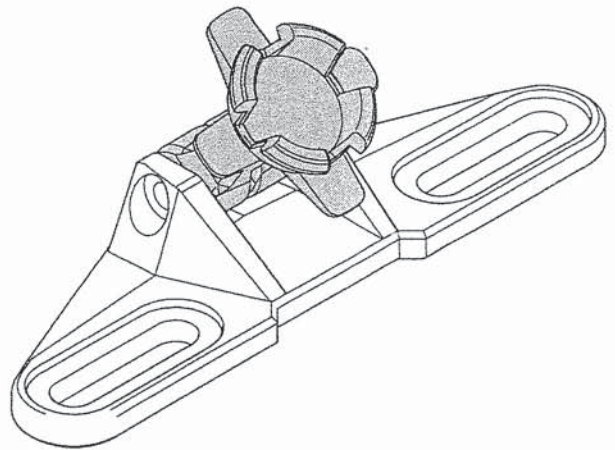
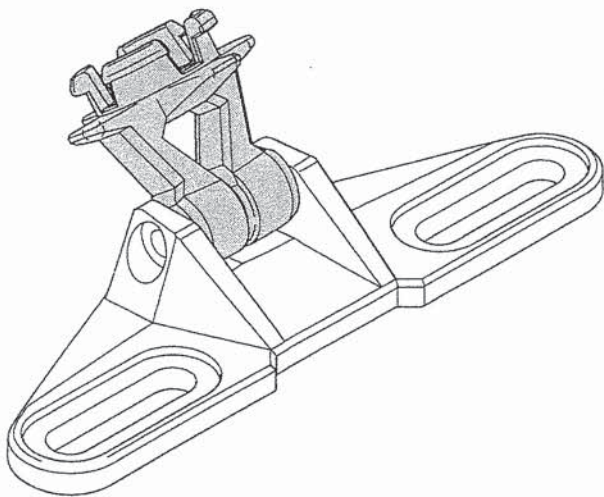

4mm

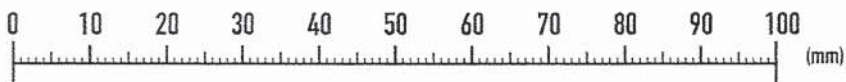

# SMART MOUNT

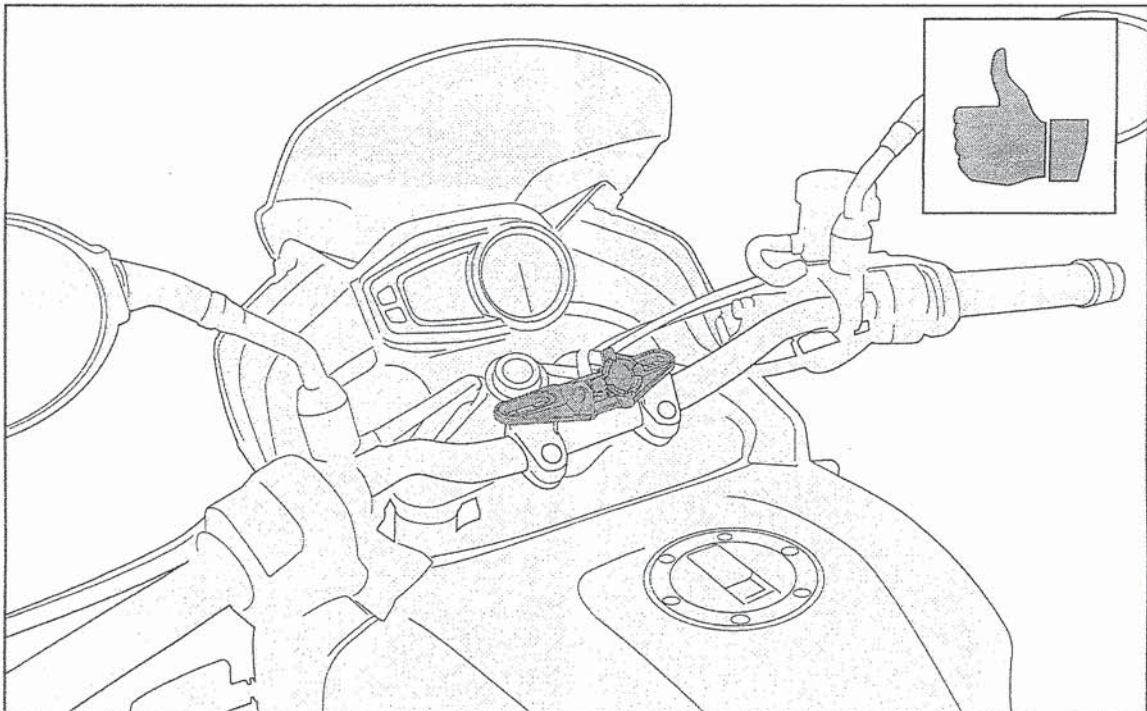
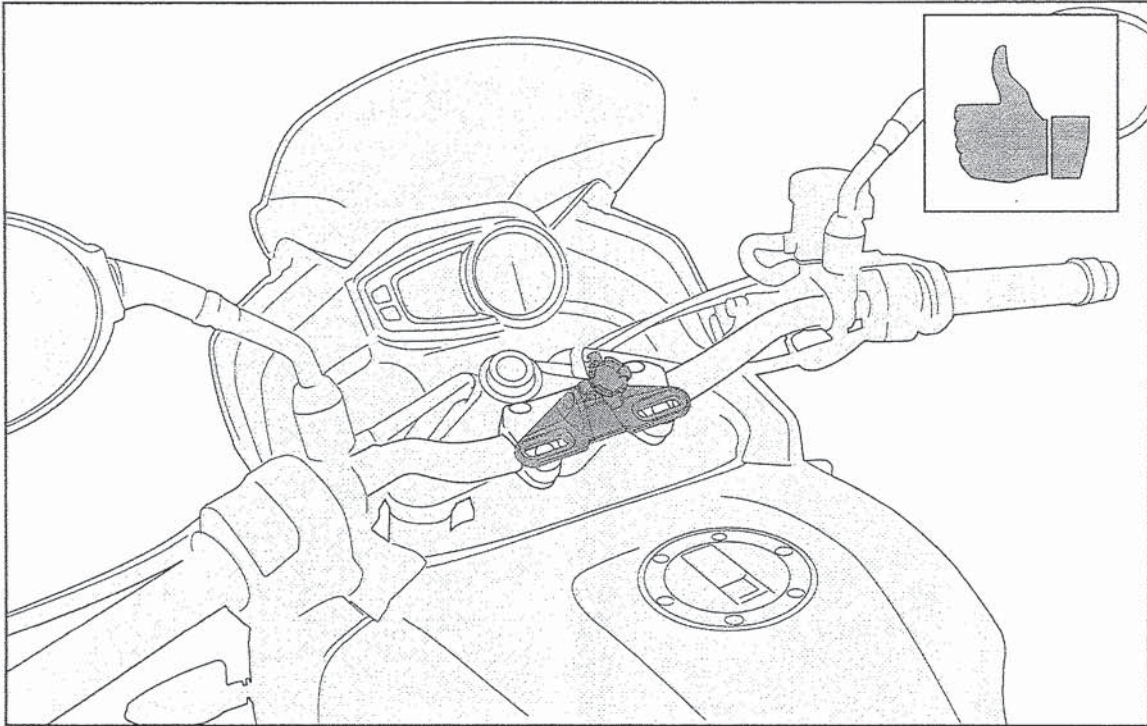

. ATTENZIONE: E' POSSIBILE MONTARE LA SMART MOUNT IN ENTRAMBE LE POSIZIONI DEI RISER ED IN ENTRAMBI GLI ORIENTAMENTI.

. WARNING: THE SMART MOUNT CAN BE FITTED IN BOTH POSITIONS OF THE RISERS AND IN BOTH DIRECTIONS.

. AVERTISSEMENT : VOUS POUVEZ ADAPTER LE SMART MOUNT DANS LES DEUX EMPLACEMENTS DES VIS DE FIXATION DU PONTET

. ACHTUNG: ES IST MÖGLICH, DIE SMART MOUNT IN BEIDE RICHTUNGEN IN DEN HALTER ZU LEGEN.

. ATENCION: ES POSIBLE MONTAR EL SMART MOUNT EN AMBAS POSICIONES DEL RISER Y EN AMBAS ORIENTACIONES.

. ATENÇÃO: O SMART MOUNT PODE MONTADO EM AMBAS AS POSIÇÕES DO SUPORTE DE GUIDÃO E EM AMBAS AS DIREÇÕES.

**KIT PER SMART BAR/SMART MOUNT - KIT FOR SMART BAR/SMART MOUNT - KIT POUR SMART BAR/SMART MOUNT  
KIT FÜR SMART BAR/SMART MOUNT - KIT PARA SMART BAR/SMART MOUNT - KIT PARA SMART BAR/SMART MOUNT**

N°	Descrizione	Caratteristiche	Codice	Quantità	
1	Distanziale - Spacer Entretoise - Distanzstück Distanciadador - Espaçador	Ø14x15 Foro 8,5mm	C14L15F8,5T	2	
2	Vite - Screw Vis - Schraube Tornillo - Parafuso	TCEI M8x50 INOX	850TCEX	2	
3	Vite - Screw Vis - Schraube Tornillo - Parafuso	TCEI M8x55 INOX	855TCEX	2	
4	Vite - Screw Vis - Schraube Tornillo - Parafuso	TCEI M8x60 INOX	860TCEX	2	
5	Rondella - Washer Rondelle - Scheibe Arandela - Arruela	Ø8 INOX	8RONX	6	

MARCA	MODELLO	850TCEX	855TCEX	860TCEX
APRILIA	SHIVER 750 (2010-2015)	X*		
APRILIA	SHIVER 750GT (2010-2015)	X*		
APRILIA	DORSODURO 750/ABS (2008-2015)	X		
APRILIA	MANA 850 (2008-2015)	X*		
APRILIA	MANA 850GT (2008-2015)	X*		
APRILIA	TUONO V4 (TUTTE LE VERSIONI 2011 - 2015)		X	
APRILIA	DORSODURO 1200/ABS (2010 - 2015)	X*		
APRILIA	CAPONORD 1200 (2013 - 2015)	X*		
BMW	G650GS (11-15)		X	
BMW	F700GS (12-15)		X	
BMW	F800GS / F650GS (08-15)		X	
BMW	F800GS ADVENTURE (13-15)		X	
BMW	F800GT (2013 - 2015)		X*	
BMW	F800R (09-14)		X	
BMW	R NINE T (2014 - 2015)		X(B)	
BMW	S1000XR (2015)			X
BMW	R1200GS ADVENTURE (2006-2013)		X(B)	
BMW	R1200GS ADVENTURE (2014 - 2015)			X
BMW	R1200GS (2004-2012)		X(B)	
BMW	R1200GS (2013-2015)			X
BMW	R1200R (2015)			X
BMW	R1200RS (2015)			X
HONDA	CBF600 S/N (2004-2012)		X	
HONDA	CTX700/N (2014-2015)		X	
HONDA	VFR 800F (2014 - 2015)	X(C)		
HONDA	CB1100 (2012-2015)	X(B)		